



**DYNATECH  
DYNAMICS AND TECHNOLOGY, S.L.**

**LIMITEUR DE VITESSE  
VEGA PLUS**

## **SOMMAIRE**

1.-	INTRODUCTION. ....	1
2.-	PRINCIPAUX COMPOSANTS.....	1
3.-	PRINCIPES DE FONCTIONNEMENT. ....	2
3.1.	Encoder.....	3
4.-	CARACTERISTIQUES TECHNIQUES. ....	14
5.-	INSTRUCTIONS D'UTILISATION ET D'ENTRETIEN.....	15
6.-	PLANS D'INSTALLATION. ....	15
7.-	CERTIFICATS D'EXAMEN CE DE TYPE .....	18

## **1.-INTRODUCTION.**

Le limiteur de vitesse VEGA PLUS, de DYNATECH, tout comme le limiteur VEGA, est conçu pour être capable, en cas de survitesse, de faire intervenir les parachutes si besoin est.

La particularité du VEGA PLUS est d'intégrer un Encodeur afin de connaître à tout moment la position de la cabine.

## **2.-PRINCIPAUX COMPOSANTS.**

Chaque limiteur est constitué des principaux éléments suivants: une poulie, un système centrifuge, une pièce de blocage, une carcasse et une plaque d'arrimage à la dalle de la salle des machines.

L'image présentée ci-après vous permet d'observer le limiteur dans son ensemble :

Où :

- (1) – Poulie Principale.
- (2) – Système Centrifuge.
- (3) – Système de Blocage.
- (4) – Plaque de fixation à la dalle
- (5) – Encoder

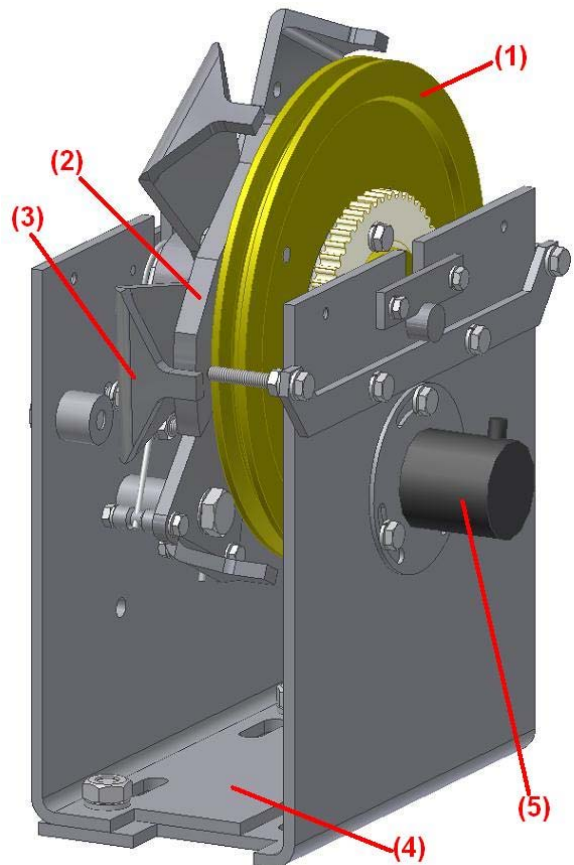

### **3.- PRINCIPES DE FONCTIONNEMENT.**

Le limiteur est de type centrifuge et peut agir en mouvement **descendant** ou **ascendant**.

Le limiteur s'arrime directement à la dalle dans la salle des machines ou sur la partie supérieure du trou de l'ascenseur, relié par le câble à sa poulie de tension située dans la fosse.

Cette poulie de tension s'arrime au guide par des brides.

Le câble circule dans la gorge du limiteur et dans celle de la poulie de tension.

Les bouts du câble se fixent au support des câbles de la barre de commande. De cette manière, lorsque la cabine atteint la vitesse de déclenchement, le mouvement relatif câble-limiteur entraînera le blocage de celui-ci.

En voici le schéma de fonctionnement :

- (1) Limiteur VEGA PLUS
- (2) Câble du limiteur
- (3) Poulie de Tension

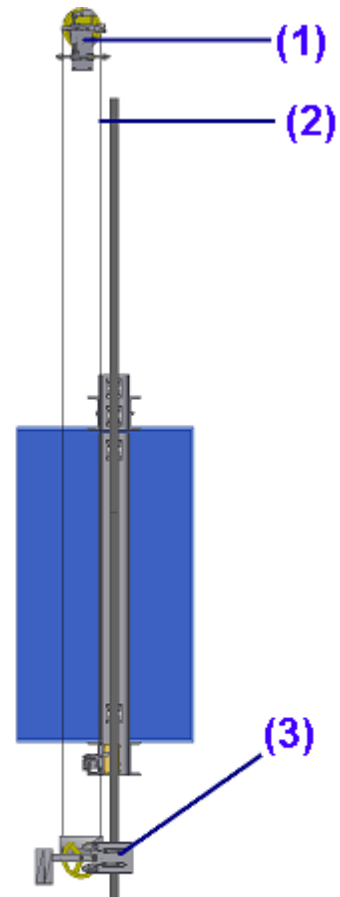

Le limiteur, comme il a été précisé précédemment, est arrimé à la dalle, dans la salle des machines ou dans le trou de l'ascenseur.

Une poulie de tension de 200 de diamètre sera placée dans la fosse pour tendre le câble qui passe dans le limiteur.

*\*Pour plus de détails, consulter le manuel Vega.*

### **3.1. Encoder**

Le limiteur VEGA Plus se caractérise par son Encodeur intégré sur l'arrière, permettant de contrôler à tout moment la position de la cabine.

*L'Encodeur tourne grâce à un système d'engrenage de roues, c'est pourquoi le rapport de vitesse est de 3. La vitesse angulaire à laquelle tourne l'encodeur est 3 fois supérieure à celle de la poulie principale.*

L'Encodeur fourni avec le VEGA plus est de la marque OMRON, modèle E6B2CWZ6C500 0,5M 24V.

C'est un encodeur incrémental de 500 impulsions, alimenté par 24 V.

*Pour plus d'information concernant l'encodeur cité ici, toute l'information tirée du catalogue d'OMRON à propos de ce produit est jointe ci-après.*

*Remarque : Si le client préfère installer son propre encodeur, il devra se mettre en contact avec Dynatech pour fournir les dimensions et la marque de l'Encodeur.*

*De cette manière, on vérifiera si son encodeur peut être installé sur le limiteur.*

# OMRON

## Rotary Encoder

## E6B2-C

### New General-purpose Incremental Rotary Encoder

- A wide operating voltage range of 5 to 24 VDC (open collector model).
- Resolution of 2,000 pulses/revolution in 40-mm housing.
- Phase Z can be adjusted with ease using the origin indicating function.
- A large load of 30 N in the radial direction and 20 N in the thrust direction is permitted.
- The load short-circuit and reversed connection protecting circuit assures highly reliable operation.
- A line driver output model is available. (Cable extends up to 100 m.)



### Ordering Information

Supply voltage	Output configuration	Resolution (P/R)	Model
5 to 24 VDC	NPN open collector output	10/20/30/40/50/60/100/200/300/360/400/500/600/720/800/1,000/1,024/1,200/1,500/1,800/2,000	E6B2-CWZ6C
12 to 24 VDC	PNP open collector output	100/200/360/500/600/1,000/2,000	E6B2-CWZ5B
5 to 12 VDC	Voltage output	10/20/30/40/50/60/100/200/300/360/400/500/600/1,000/1,200/1,500/1,800/2,000	E6B2-CWZ3E
5 VDC	Line driver output	10/20/30/40/50/60/100/200/300/360/400/500/600/1,000/1,024/1,200/1,500/1,800/2,000	E6B2-CWZ1X

Note: When ordering, specify the resolution together with the model number.

### Accessories (Order Separately)

Name	Model
Coupling	E69-C06B (attachment)
	E69-C68B
	E69-C610B
	E69-C06M
Flange	E69-FBA
	E69-FBA02 (E69-2 Mounting Bracket included)
Mounting Bracket	E69-2

### Application Example

#### Filling Control

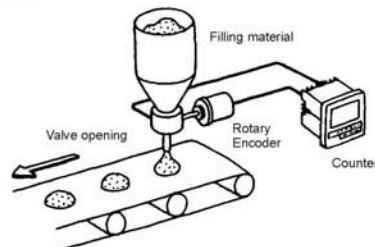

E6B2-C

OMRON

E6B2-C

## Specifications

### ■ Ratings/Characteristics

#### Electrical

Item	E6B2-CWZ6C	E6B2-CWZ5B	E6B2-CWZ3E	E6B2-CWZ1X
Power supply voltage	5 VDC -5% to 24 VDC +15%	12 VDC -10% to 24 VDC +15%	5 VDC -5% to 12 VDC +10%	5 VDC ±5%
Current consumption (see note 3)	70 mA max.	80 mA max.		130 mA max.
Resolution	10/20/30/40/50/60/100/200/300/360/400/500/600/720/800/1,000/1,024/1,200/1,500/1,800/2,000 P/R	100/200/360/500/600/1,000/2,000 P/R	10/20/30/40/50/60/100/200/300/360/400/500/600/1,000/1,200/1,500/1,800/2,000 P/R	10/20/30/40/50/60/100/200/300/360/400/500/600/1,000/1,024/1,200/1,500/1,800/2,000 P/R
Output phases	A, B, and Z (reversible)			A, $\bar{A}$ , B, $\bar{B}$ , Z, $\bar{Z}$
Output configuration	Open collector	Open collector	Voltage	Line driver (see note 2)
Output capacity	30 VDC max. 35 mA max. Residual voltage: 0.4 V max.	35 mA max. Residual voltage: 0.4 V max.	20 mA max. Residual voltage: 0.4 V max.	AM26LS31 equivalent Output current: High level = $I_o = -20$ mA Low level = $I_s = 20$ mA Output voltage: High level = $V_o = 2.5$ V min. Low level = $V_s = 0.5$ V max.
Max. response frequency (see note 1)	100 kHz	50 kHz	100 kHz	
Phase difference on output	90°±45° between A and B (1/4T±1/8T)			
Rise and fall times of output	1 $\mu$ s max. (control output voltage: 5 V; load resistance: 1 k $\Omega$ ; cable length: 0.5 m)	1 $\mu$ s max. (cable length: 2 m; $I_{sink}$ : 10 mA max.)	1 $\mu$ s max. (cable length: 0.5 m; $I_{sink}$ : 10 mA max.)	0.1 $\mu$ s max. (cable length: 0.5 m; $I_o$ : -20 mA; $I_s$ : 20 mA)
Insulation resistance	20 M $\Omega$ min. (at 500 VDC) between carry parts and case			
Dielectric strength	500 VAC, 50/60 Hz for 1 min between carry parts and case			

- Note:**
- The maximum electrical response revolution is determined by the resolution and maximum response frequency as follows:  
Maximum electrical response frequency (rpm) = Maximum response frequency/resolution x 60  
This means that the E6B2-C Rotary Encoder will not operate electrically if its revolution exceeds the maximum electrical response revolution.
  - The line driver output is a data transmission circuit compatible with RS-422A and long-distance transmission is possible with a twisted-pair cable.
  - An inrush current of approximately 9 A will flow for approximately 0.3 ms when the power is turned ON.

#### Mechanical

Item	E6B2-CWZ6C	E6B2-CWZ5B	E6B2-CWZ3E	E6B2-CWZ1X
Shaft loading	Radial: 30 N Thrust: 20 N			
Moment of inertia	1 x 10 <sup>-6</sup> kg • m <sup>2</sup> max.; 3 x 10 <sup>-7</sup> kg • m <sup>2</sup> max. at 600 P/R max.			
Starting torque	980 $\mu$ N • m max.			
Max. permissible revolution	6,000 rpm			
Vibration resistance	Destruction: 10 to 500 Hz, 150 m/s <sup>2</sup> or 2-mm double amplitude for 11 min 3 times each in X, Y, and Z directions			
Shock resistance	Destruction: 1,000 m/s <sup>2</sup> 3 times each in X, Y, and Z directions			
Weight	Approx. 100 g max. (cable length: 0.5 m)			

#### Environmental

Item	E6B2-CWZ6C	E6B2-CWZ5B	E6B2-CWZ3E	E6B2-CWZ1X
Ambient temperature	Operating: -10°C to 70°C (with no icing) Storage: -25°C to 85°C (with no icing)			
Ambient humidity	Operating: 35% to 85% (with no condensation)			
Degree of protection	IEC60529 IP50			

**E6B2-C** ————— **OMRON** ————— **E6B2-C**

**Operation**

■ **Output Circuits**

**E6B2-CWZ6C**

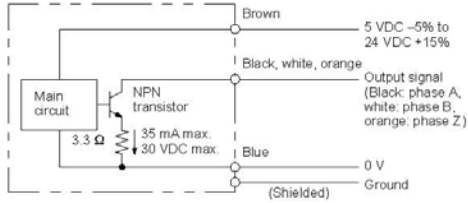

**E6B2-CWZ5B**

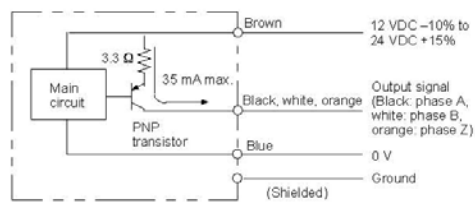

**E6B2-CWZ3E**

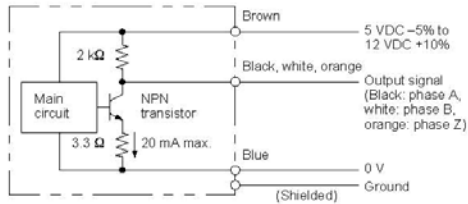

**E6B2-CWZ1X**

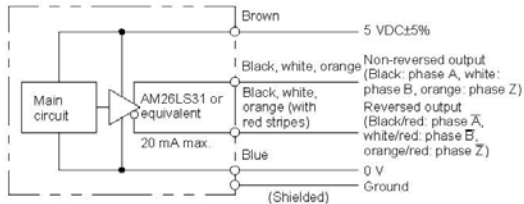

**E6B2-C** **OMRON** **E6B2-C**

**■ Timing Charts**  
**Open Collector Output**  
 E6B2-CWZ6C  
 E6B2-CWZ5B

Direction or resolution: CW  
 (As viewed from the end of the shaft)

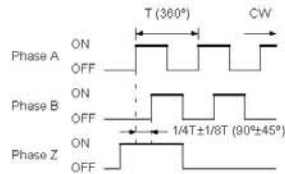

**Note:** Phase A is  $1/4 \pm 1/8T$  faster than phase B. The ONs in the above timing chart mean that the output transistor is ON and the OFFs mean that the output transistor is OFF.

Direction or resolution: CCW  
 (As viewed from the end of the shaft)

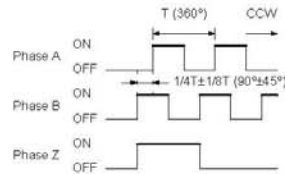

**Note:** Phase A is  $1/4 \pm 1/8T$  slower than phase B.

**Voltage Output**  
 E6B2-CWZ3E

Direction or resolution: CW  
 (As viewed from the end of the shaft)

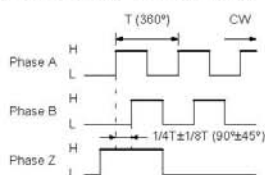

**Note:** Phase A is  $1/4 \pm 1/8T$  faster than phase B.

Direction or resolution: CCW  
 (As viewed from the end of the shaft)

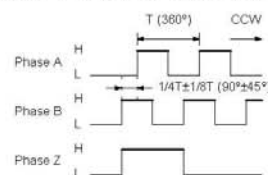

**Note:** Phase A is  $1/4 \pm 1/8T$  slower than phase B.

**Line Driver Output**  
 E6B2-CWZ1X

Direction or resolution: CW  
 (As viewed from the end of the shaft)

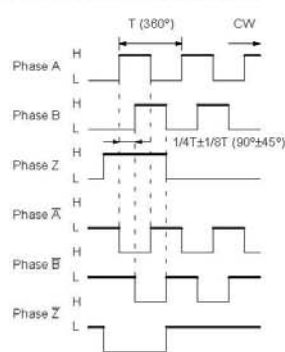

Direction or resolution: CCW  
 (As viewed from the end of the shaft)

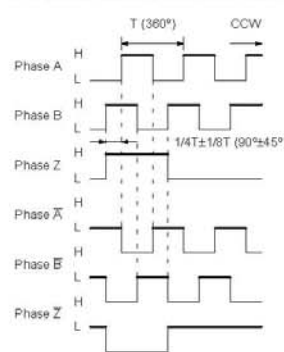

**Note:** The line driver output circuit is an RS-422A data transmission circuit consisting of two balanced output lines. The relationship between the two output lines is on an equal status. This means that if the level of the signal on a line is H, the level of the signal on the other line is L. The noise-resistive line driver output circuit assures high-speed data transmission.

**E6B2-C** ————— **OMRON** ————— **E6B2-C**

■ **Input to More than One Counter from Encoder (with Voltage Output)**

Use the following formula to obtain the number of counters to be connected to a single E6B2-C Rotary Encoder.

$$\text{Number of counters (N)} = \frac{R1 (E-V)}{V \times R2}$$

- E: Voltage supplied to Rotary Encoder
- V: Minimum input voltage of the counter
- R2: Output resistance of the Rotary Encoder
- R1: Input resistance of the counter

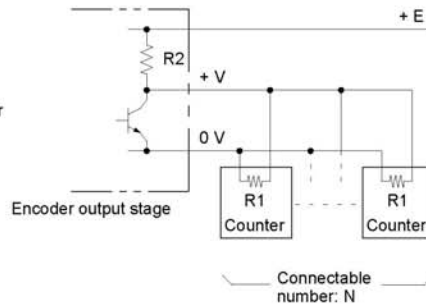

■ **Origin Indication**

It is easy to adjust the position of phase Z with the origin indication function. The following illustration (on the left-hand side) shows the relationship between phase Z and the origin. Set cut face D to the origin as shown in the illustration (on the right-hand side).

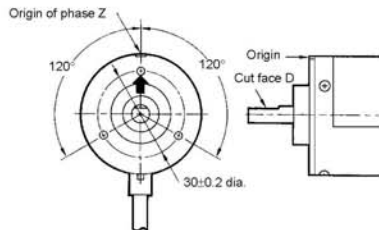

■ **Output Protection Circuit**

The E6B2-C (open collector model with voltage output) incorporates a circuit preventing the E6B2-C from damage due to a short-circuited load and reversed connection.

**E6B2-C** ————— **OMRON** ————— **E6B2-C**

## Dimensions

**Note:** All units are in millimeters unless otherwise indicated.

**E6B2-C**

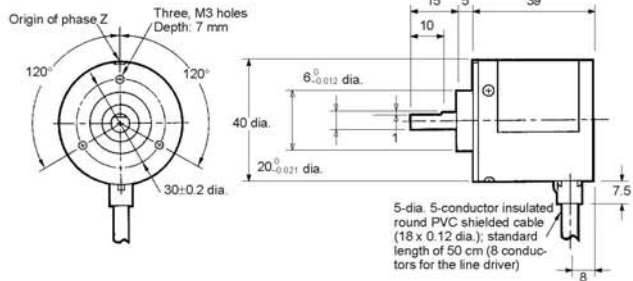

**Coupling**  
**E69-C06B**  
**(Included)**

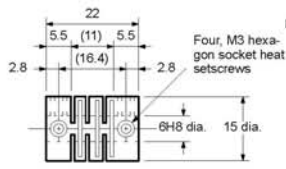

**Note:** The coupling is made of glass-reinforced PBT.

**E69-C68B**  
**(Sold Separately, Different Diameter)**

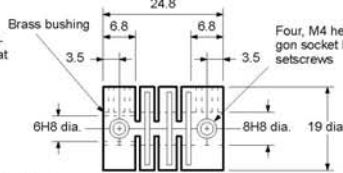

**E69-C610B**  
**(Sold Separately, Different Diameter)**

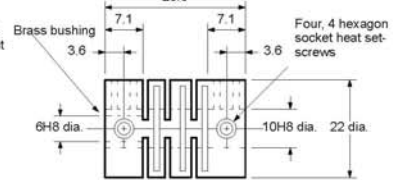

**E69-C06M**  
**(Sold Separately, Different Diameter)**

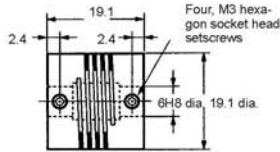

**Note:** The coupling is made of extra super duralumin.

**Flange (Sold Separately)**

**E69-FBA**

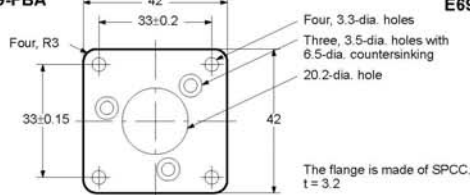

**E69-FBA02**

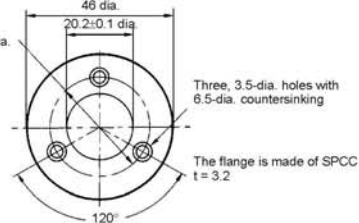

**Mounting Bracket (Three Pieces as a Set)**  
**E69-2 (One Set Provided with the E69-FBA02)**

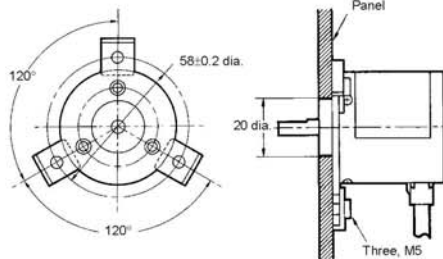
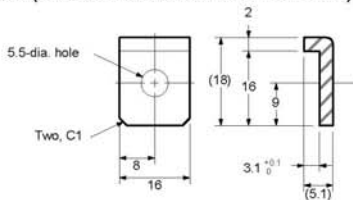

## Installation

### ■ Connection

Be sure to connect the external terminals correctly or the E6B2-C Rotary Encoder may be damaged.

#### E6B2-CWZ6C/-CWZ5B/-CWZ3E

Color	Terminal
Brown	Power supply (+V <sub>CC</sub> )
Black	Output phase A
White	Output phase B
Orange	Output phase Z
Blue	0 V (common)

#### E6B2-CWZ1X

Color	Terminal
Brown	Power supply (+V <sub>CC</sub> )
Black	Output phase A
White	Output phase B
Orange	Output phase Z
Black/red stripes	Output phase A
White/red stripes	Output phase B
Orange/red stripes	Output phase Z
Blue	0 V (common)

Note: Receiver: AM26LS32 equivalent

- Note:
1. The external conductor (shield) of the shielded cable is not connected to the internal conductors nor to the case.
  2. All the phases A, B, and Z are in the same circuit.
  3. Connect the GND to the 0-V line or to the ground terminal.

### ■ Connections with Peripheral Devices

Coupling	Specification	Resin, standard type				Resin, non-standard opening diameter		Metal	
	Internal shaft diameter (mm)	4 (H8), 13	6 (H8), 15	8 (H8), 19	10 (H8), 22	6/8 (H8), 19	6/10 (H8), 22	6 (H8), 19.1	10 (H8), 25.4
Rotary Encoder	Model	E69-C04B	E69-C06B	E69-C08B	E69-C10B	E69-C68B	E69-C610B	E69-C06M	E69-C10M
<b>E6B2, 6-mm diameter</b>		C	A	C	C	B	B	B	C

- Note:
- A: Possible to connect directly in most cases.
  - B: Possible to connect, but an independent power supply or pull-up resistor will be required.
  - C: Impossible to connect.

### Connection Examples

#### Connection to H7CR-CW Counter

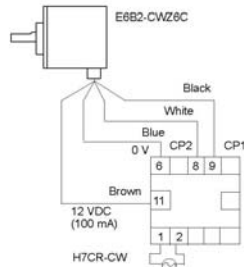

#### Features of H7CR

DIN-sized (DIN 48) counter incorporating a prescale function converting the measured value to the actual value.  
Synchronized output and  $\pm$  indication are available ( $\pm$  area models).  
Models with a general-purpose six-digit display and four-digit display are available.



#### Connection to K3NR-NB□□□/ K3NP-NB□□□ Rotary Intelligent Signal Processor

#### Features of K3NR/K3NP

Each model incorporates a prescale function with an input range of 50 kHz and the measurement accuracy is 0.006%.

A variety of outputs, including relay, transistor, BCD, linear, and communications outputs, are available.

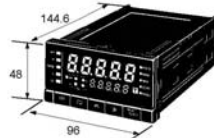

## Precautions

### ■ Mounting

#### Mounting Procedure

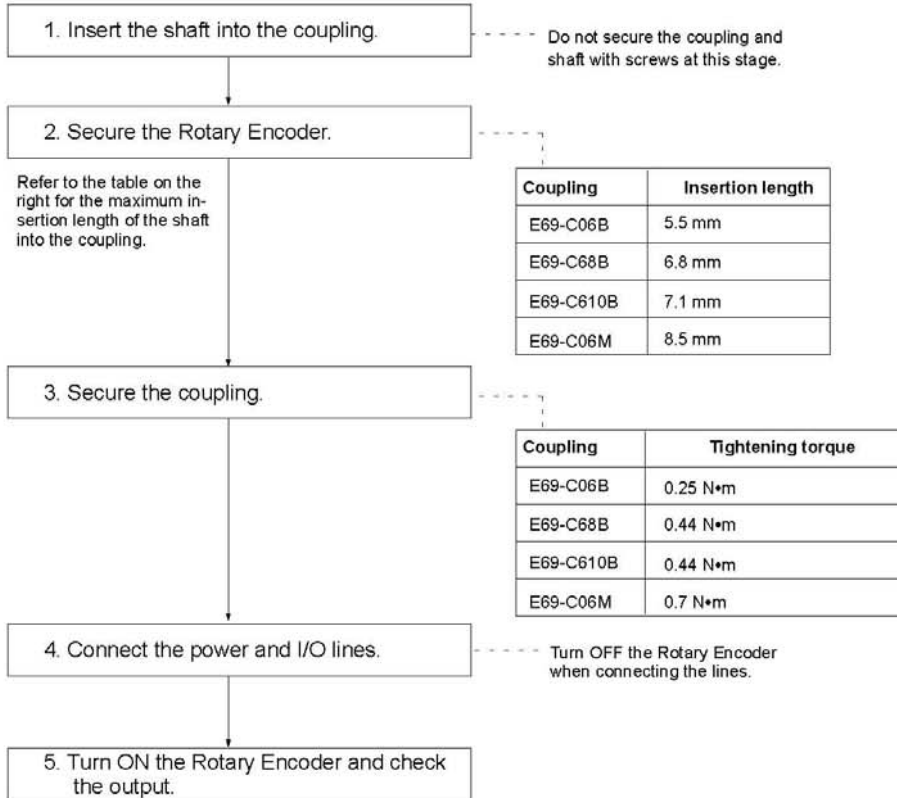

### Installation

Be careful not to spray water or oil onto the E6B2-C Rotary Encoder. The E6B2-C Rotary Encoder consists of high-precision components. Handle it with utmost care and do not drop the Rotary Encoder, otherwise malfunctioning may result.

When the E6B2-C Rotary Encoder is used in reversing operation, pay utmost attention to the mounting direction of the E6B2-C Rotary Encoder and the directions of increment and decrement rotation.

To match phase Z of the E6B2-C Rotary Encoder and the origin of the device to be connected to the E6B2-C Rotary Encoder, confirm the phase Z output when connecting the device.

Do not impose an excessive load on the shaft if the shaft is connected to a gear.

If the Rotary Encoder is mounted with screws, the tightening torque must be approximately 0.49 N•m.

Refer to the following illustrations when using a standard coupling.

<b>Eccentricity tolerance</b>	
<b>Declination tolerance</b>	
<b>Displacement tolerance in the shaft direction</b>	

If the eccentricity or declination value exceeds the tolerance, an excessive load imposed on the shaft may damage the Rotary Encoder or shorten the life of the Rotary Encoder.

**Mounting**

When connecting the shaft of the Rotary Encoder with a chain timing belt or gear, connect the chain timing belt or gear with the shaft via the bearing and coupling as shown in the following illustration.

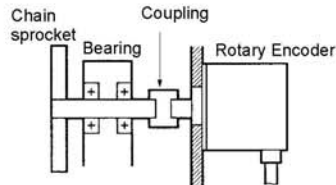

Do not hit the shaft or coupling with a hammer when inserting the shaft into the coupling. No shock must be applied to the shaft or coupling.

When connecting or disconnecting the coupling, do not bend, press, or pull the coupling excessively.

**Bearing Life**

The following graph shows the life expectancy (theoretical values) of the bearing with radial and thrust loads imposed on the bearing.

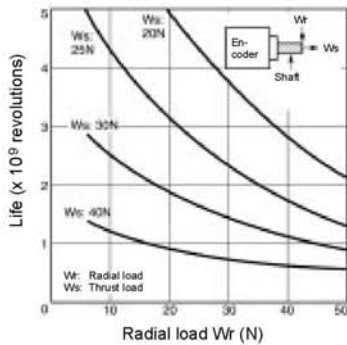

**Wiring**

If the Rotary Encoder is mounted in a panel, do not pull the cable with more than a force of 29.4 N.

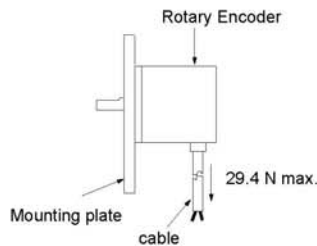

Do not pull the cable of the E6B2-C rotary Encoder after the E6B2-C Rotary Encoder is mounted to a panel. Do not apply any shock to the hollow shaft or the body.

**Connections**

When extending the cable, select the kind of cable with care, taking the response frequency into consideration. The longer the cable is, the more the residual voltage increases due to the resistance of the cable and the capacitance between the wires. As a result, the waveform will be distorted.

OMRON recommends models with a line driver output if the cable needs to be extended.

To reduce inductive noise, the cable must be laid the shortest distance, especially when the signal is input to an IC.

Insert a surge absorber between the power supply terminals if there is any surge.

To reduce noise, the total cable length must be as short as possible.

Incorrect pulses may be generated when the E6B2-C Rotary Encoder is turned ON or OFF. Do not use the connected device for 0.1 s after the E6B2-C Rotary Encoder is turned ON and for 0.1 s before the E6B2-C Rotary Encoder is turned OFF.

**Cable Extension**

The rise time of each output waveform will increase when the cable is extended. This will affect the phase difference characteristics of phases A and B.

The rise time varies with the resistance of the cable, the kind of cable, and the length of the cable.

The residual output voltage will increase according to the length of the cable.

**E6B2-CWZ6C**

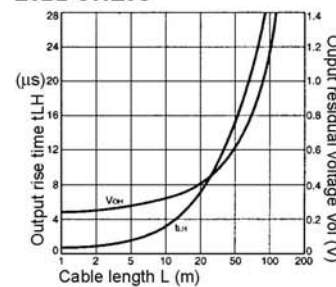

**Measurement example**

- Power supply voltage: 5 VDC
- Load resistance: 1 k $\Omega$
- (Residual output voltage was measured at a load current of 35 mA.)
- Cable: Dedicated cable

**Preventing Miscounting**

If the operation of the E6B2-C Rotary Encoder is stopped near a signal rising or falling edge, incorrect pulses may be generated, in which case the E6B2-C Rotary Encoder will miscount. Use an increment-decrement counter to prevent miscounting.

**E6B2-C** ————— **OMRON** ————— **E6B2-C**

**Extension of Line Driver Output**

Use twisted-pair cable to extend the line driver cable.  
 Recommended cable: Tachii Densen's TKVVBS4P-02A  
 Use an RS-422A receiver.

The twisted-pair wires shown in the following illustration are suitable for RS-422A signal transmission. Normal mode noise can be eliminated by twisting the wires because the generated electrical forces on the lines cancel each other.

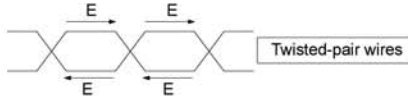

Check that the E6B2-C is supplied with 5 VDC when a line driver output is used. There will be an approximately 1 V voltage drop if the cable length is 100 m.

**Using a Line Receiver IC**

Recommended IC: Texas Instruments

**AM26LS32, AM26C32**

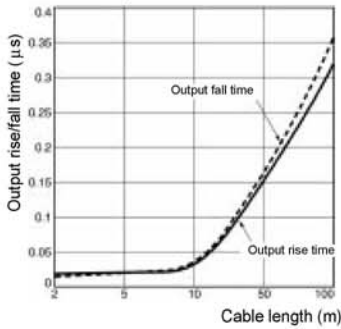

**Others**

**Input to More than One Counter from Rotary Encoder (with Voltage Output)**

Use the following formula to obtain the number of counters to be connected to a single E6B2-C Rotary Encoder.

$$\text{Number of counters (N)} = \frac{R1(E-V)}{V \cdot R2}$$

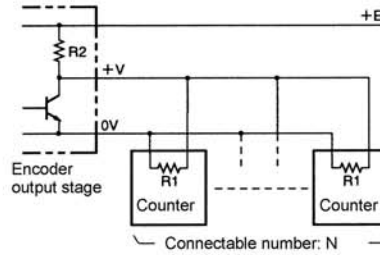

- E: Voltage supplied to Rotary Encoder
- V: Minimum input voltage of the counter
- R1: Input resistance of the Rotary Encoder
- R2: Output resistance of the Rotary Encoder

#### **4.- CARACTERISTIQUES TECHNIQUES.**

- **Appareil** : Limiteur de vitesse
- **Modèle** : VEGA PLUS
- **Entreprise fabricante** :  
DYNATECH, DYNAMICS & TECHNOLOGY, S.L.
- **Champ d'action** :  
Vitesse nominale maximale: 2.40 m/s  
Vitesse de déclenchement maximale: 3 m/s  
  
Vitesse nominale minimale: 0.1 m/s  
Vitesse de déclenchement minimale:
  - Entre 0.4 - 0.7 m/s , le limiteur est **UNIDIRECTIONNEL**
  
  - Entre 0.7 – 2.87 m/s le limiteur est **BIDIRECTIONNEL**
- **Câble** :  
Diamètre : 6 mm, 6,3 mm, 6,5 mm.  
Composition : 6 x 19 + 1
- **Pré-tension du câble** :  
500 N  
Cette tension est produite en positionnant la poulie de tension de manière que la barre reste en position horizontale.
- **Tension produite sur le câble par l'enclavement** :  
Supérieure de 300 N
- **Diamètre de la poulie** : 200 mm
- **Contact de survitesse.**
- **Autres caractéristiques** :
  - Possibilité de monter plusieurs dispositifs :
    - Actionnement à distance (24, 48, 190 V DC)
    - Réarmement automatique (24, 48, 190 V DC)
    - Système Parking (24, 48, 190 V DC)
    - Limiteur à déclenchement unidirectionnel ou bidirectionnel.

- Possibilité de monter un Encodeur pour connaître la position de la cabine à tout moment. (Modèle VEGA PLUS)
- Poulie avec la gorge endurcie
- **Parachutes avec lesquels il peut être utilisé :**
  - Tous ceux dont la vitesse de déclenchement peut être atteinte par le limiteur de vitesse.

## **5.-INSTRUCTIONS D'UTILISATION ET D'ENTRETIEN.**

Les instructions et conseils pour l'utilisation et l'entretien du limiteur sont tout à fait identiques à ceux du limiteur VEGA PLUS.

Concernant l'encodeur, il faut faire en sorte que celui-ci soit exempt de saleté et vérifier la non-détection d'un fonctionnement irrégulier le concernant, comme des bruits bizarres ou des mouvements brusques.

## **6.- PLANS D'INSTALLATION.**

Les plans suivants peuvent être d'un grand secours pour l'adaptation et l'installation du limiteur de vitesse VEGA PLUS:

**Vue latérale :**

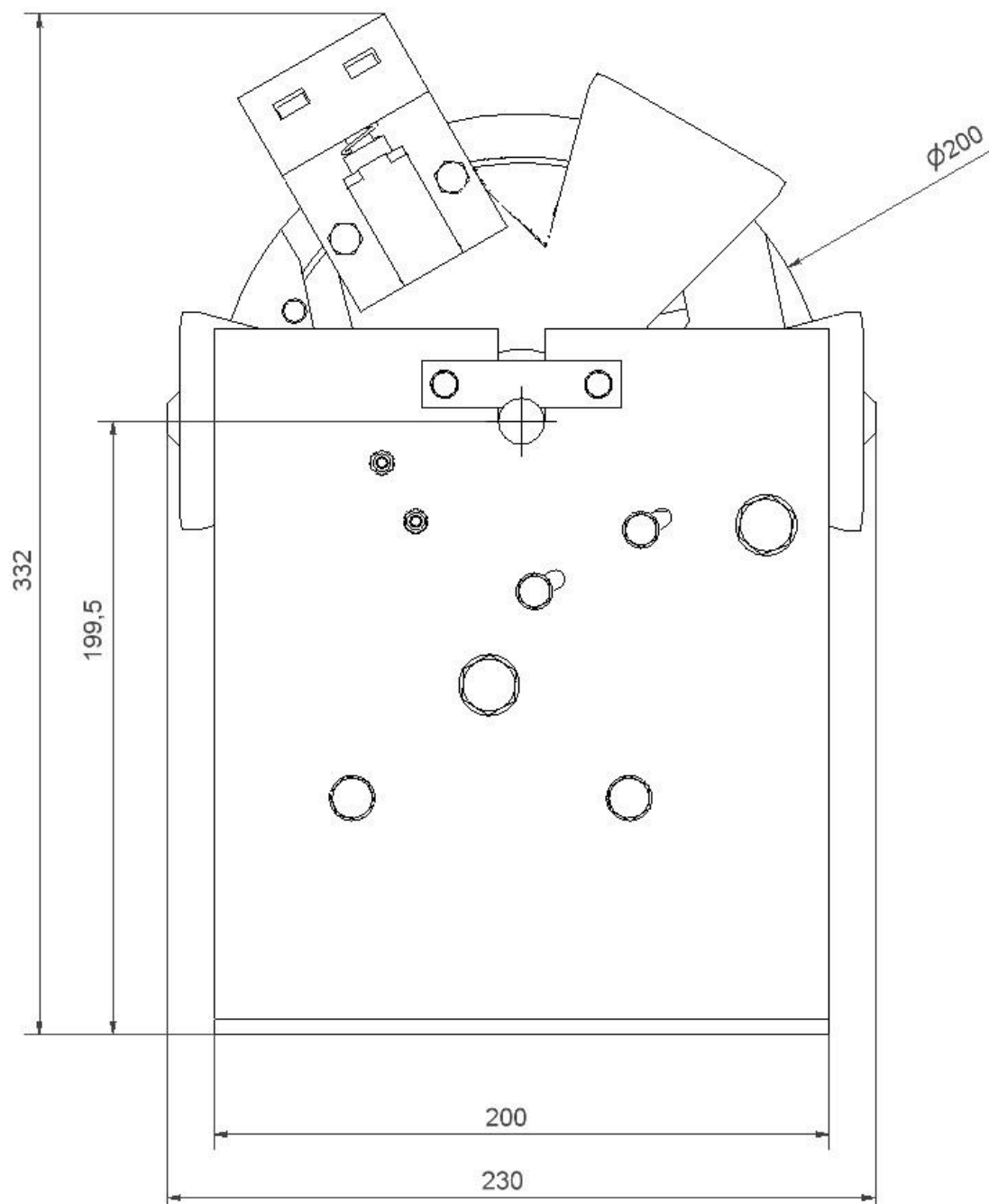

**Profil :**

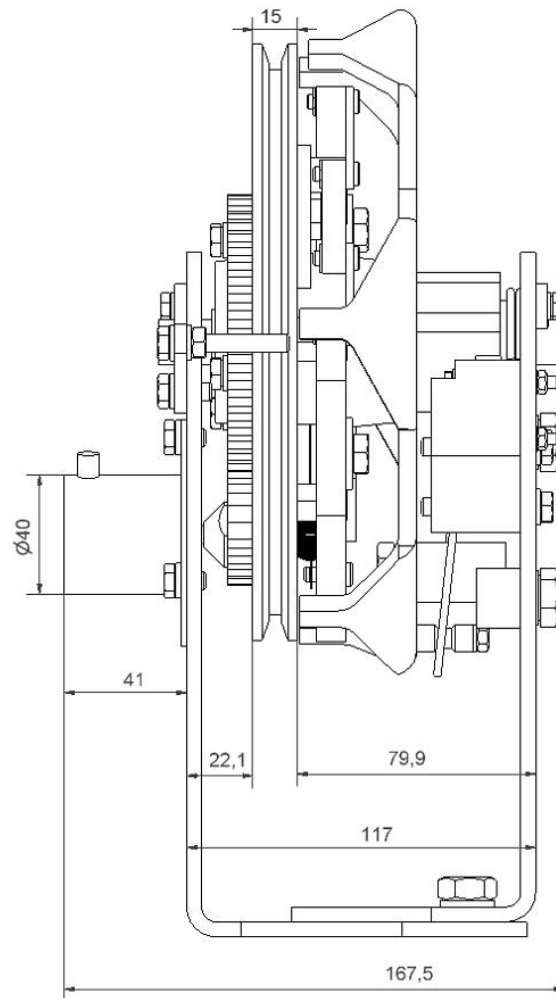

**Vue en plan:**

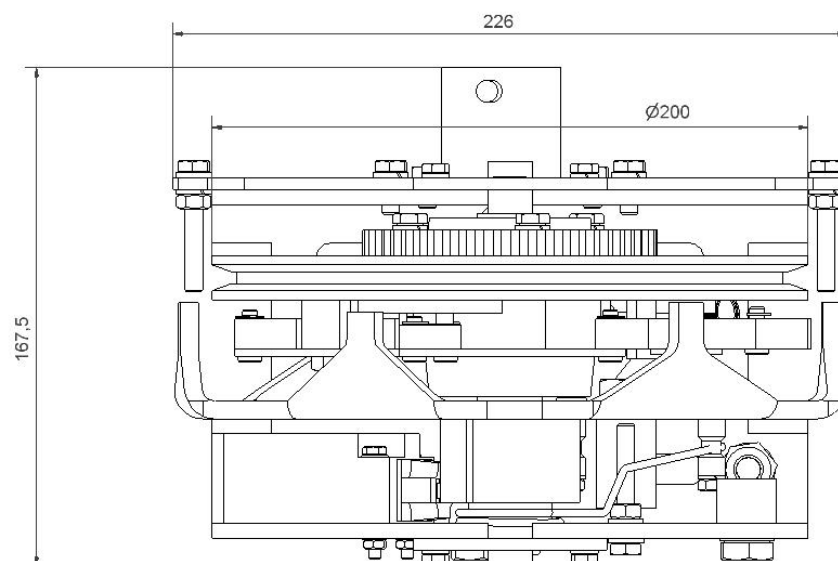

## **7.- CERTIFICATS D'EXAMEN CE DE TYPE**

Le certificat de type pour le limiteur VEGA PLUS est le même que celui du limiteur VEGA ; par conséquent, si vous souhaitez consulter les certificats, reportez-vous au manuel du limiteur VEGA.